

# Smart I/O Modules

## with BACnet MS/TP & Modbus RTU communications

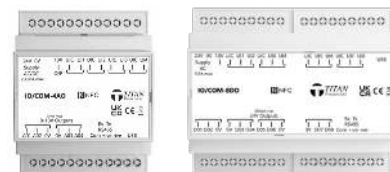

The Smart Input / Output (IO) modules from Titan Products are designed to provide additional and cost effective networkable device points to a BACnet MS/TP or Modbus RTU network.

The devices are available with 4 or 8 universal input configurations and a variety of output options that include relay, digital and analogue outputs designed to suit a wide range of HVAC and BMS applications for Monitoring, Controlling and Positioning devices such as:

- Ventilation Dampers
- Valves
- Light Levels
- Variable Speed Drives (Pumps, Fan etc.)
- Energy Meters

The modules are supplied with Near Field Communication (NFC) capabilities as standard. NFC allows data to pass between two devices at small distances or via touch. This data transfer allows the IO modules to be set up via the Titan commissioning app.

Using the app, the commissioning process can be completed with or without power applied to the Smart IO units providing extremely quick, simple and flexible set up. Each module can be networked addressed, universal inputs configured and read, outputs read, and device information viewed.

Alternatively, the modules can be set up via a PC / laptop program (supplied separately).

The universal inputs can be used to monitor:

- Resistive inputs
- 0-10V, 0-20mA active inputs
- Digital ON/OFF contact switches
- Digital pulsed inputs.

### Specification

Power Supply:	See below table
Universal Inputs:	Resistive NTC: 10K3, 10K4, 20K6 PTC: NI1000, PT1000
	Active 0-20mA with external 100ohm resistor (150ohm Max), 0-10V (12 bit)
Output Types:	Digital ON/OFF contact, Pulse Count Analogue (rated 5mA / 16 Bit) Digital (rated 350mA) Relay (rated 3A at 240V)
Accuracy / Resolution:	Analogue: +/-0.1V Resistive: +/-0.5°C Digital Pulse: 25ms pulse width min (up to 65535 counts, loop back to 0 on overflow)
Communications:	BACnet MS/TP Modbus RTU
LED Indication:	Tx/Rx communications
Operating Temp:	0 to 50°C
Operating Humidity:	5 to 80% non-condensing
Enclosure:	L94-VO (IP20)
Mounting:	DIN Rail
Terminals:	1.0mm recommended
Approvals:	UKCA / CE / RoHS
Country of origin:	UK

### Models:

Part Code	No. of UI	Outputs Configuration	Power Consumption*	Power Supply
IO/COM-4AO	4	4 x Analogue (AO)	200mA max	24V AC/DC
IO/COM-4DO	4	4 x Digital (DO)	1.6A max	24V AC
IO/COM-4R	4	4 x Relay (RO)	200mA max	24V AC/DC
IO/COM-8AO	8	8 x Analogue (AO)	300mA max	24V AC/DC
IO/COM-8DO	8	8 x Digital (DO)	3.5A max	24V AC
IO/COM-8R	8	8 x Relay (RO)	300mA max	24V AC/DC
IO/COM-4AO-4DO	8	4 x Analogue (AO) / 4 x Digital (DO)	1.9A max	24V AC

\*Power consumption figure includes total connected output loads.

### NFC Commissioning App



Fully compatible with Android 9, 10 and 11 devices, as well as iPhone 8 and later models, the app allows setup and selection of:

- > the communications type (BACnet MS/TP or Modbus)
- > the communications addressing, baud rate and parity settings
- > the universal inputs (UI) setup

The Smart IO unit setup and model types can also be read back by a simple tap of the device.



t: +44 (0)161 406 6480 • e: sales@titanproducts.com • w: www.titanproducts.com

UK DESIGNED, DEVELOPED AND MANUFACTURED

Ref: SKU 266 V4



## Dimensions

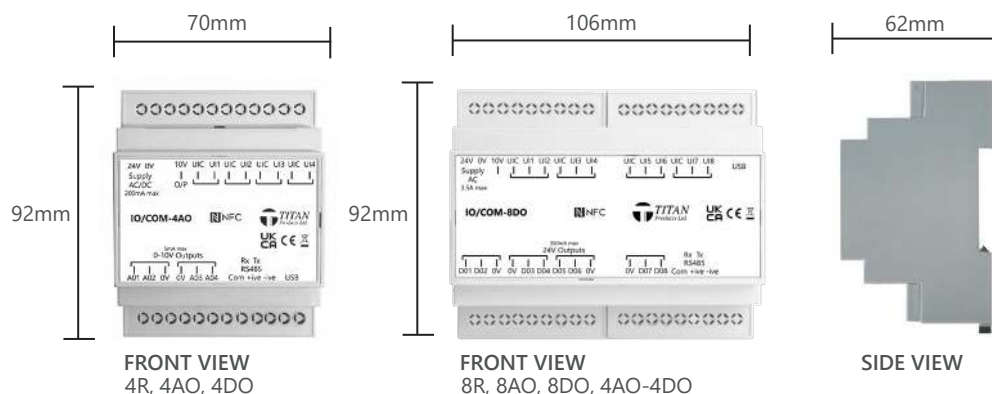

## Preparation and Disposal:

Unpack the Smart IO module from the recyclable cardboard packaging. Inspect the package contents for damaged or missing components. If damaged, notify the appropriate carrier at once and return any damaged components for immediate repair or replacement. Dispose of packaging at appropriate site for recycling.

### Included in package:

- Smart IO module
- RS485 plug-in connector

*Note: If not using the commissioning app, the IO/COMKIT will be required. This is supplied separately.*

### Recycling:

All plastic and metal parts are recyclable. The printed circuit board may be sent to any PCB recovery contractor to recover some of the components for any metals such as gold and silver.

### Disposal:

At the end of their useful life the packaging and product should be disposed of in accordance with the below depending on the country of your disposal:

- WEEE Directive 2012/19/EU and its amendments (EU).
- The Waste Electrical and Electronic Equipment Regulations 2013 (as amended).



Do not dispose of with normal household waste. Do not burn.

### Precautions:

This document uses the following warning and caution conventions:

1) **CAUTION:** Cautions remind the reader to be careful. They alert readers to situations where there is a chance that the reader might perform an action that cannot be undone, might receive unexpected results, or might lose data. Cautions contain an explanation of why the action is potentially problematic.

2) **WARNING:** Warnings alert the reader to proceed with extreme care. They alert the user to situations where there is a chance that the user might do something that can result in personal injury or equipment damage. Warnings contain an explanation of why the action is potentially dangerous.

### Safety Precautions:

The following items are warnings of a general nature relating to the installation and start-up of the Smart IO modules. It is essential to be sure to pay attention to these warnings to prevent personal injury or equipment damage.

#### **WARNING**

The Smart IO modules are powered by 24V AC at 50/60 Hz or 24V DC. There is potential for up to 240V AC to be present at the Relay Output terminals (reference R1 – R8 dependant on product type). Disconnect power before installation or servicing to prevent electrical shock or equipment damage. Make all connections in accordance with national and local electrical codes. Use only copper conductors with ferrules to contain cable strands. To reduce the risk of fire or electrical shock, install in a controlled environment relatively free of contaminants. This device is intended for use only as a monitoring and control device. To prevent data loss or equipment damage, do not use it for any other purpose.

## Static Discharge Precautions

Static charges produce voltages high enough to damage electronic components. The microprocessors and associated circuitry within a Smart IO modules controller are sensitive to static discharge. Follow these precautions when installing, servicing, or operating the system:

**CAUTION** Work in a static-free area.  
Discharge any static electricity you may have accumulated. Discharge static electricity by touching a known, securely grounded object. Do not handle the printed circuit board (PCB) for any reason.

## Mounting

Mount the Smart IO modules in a location that allows clearance for wiring, servicing and module removal.

### Environmental Requirements:

Note the following requirements for the Smart IO mounting location:

- This product is intended only for indoor use. Do not expose the unit to ambient conditions outside of the stated temperature and humidity ranges.
- If mounting inside an enclosure, that enclosure should be designed to keep the unit within its required operating range considering a 15VA dissipation by the controller, plus dissipation from any other devices installed in the same enclosure. This is especially important if the controller is mounted inside an enclosure with other heat producing equipment.

### Do not mount the unit:

- In an area where excessive moisture, corrosive fumes, or explosive vapours are present.
- Where vibration or shock is likely to occur.
- In a location subject to electrical noise. This includes the proximity of large electrical contractors, electrical machinery, welding equipment, and spark igniters, and variable frequency drives.

### Physical Mounting:

The following information applies to physically mounting the unit

- You can mount the Smart IO modules in any orientation. But preferably horizontally with access to the bottom mounting clip. It is not necessary to remove the top cover before mounting.
- The Smart IO modules has a moulded DIN rail slot and locking clip for direct mounting onto a DIN top hat rail size 35mm.
- Mounting on a DIN rail ensures accurate alignment of connectors between all devices.

### DIN Rail Mounting:

#### Fixing to the DIN Rail

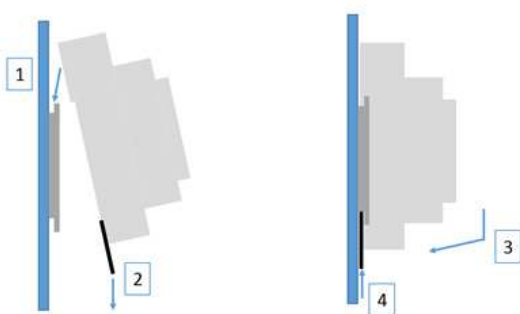

1. Fix top clips over DIN rail.
2. Pull down bottom clip using screwdriver.
3. Close controller towards DIN rail.
4. Push up bottom clip to fix securely to DIN rail.

#### Removing from the DIN Rail

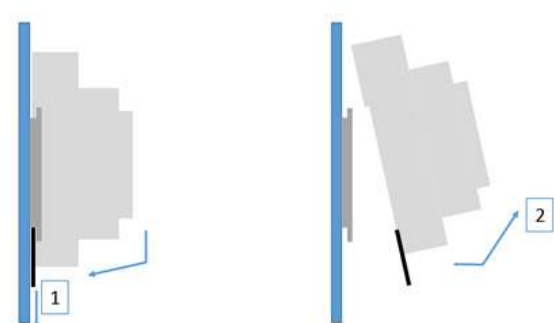

1. Pull down bottom clip with screwdriver.
2. Lift controller away from DIN rail.

## Connections

### IO/COM-4AO

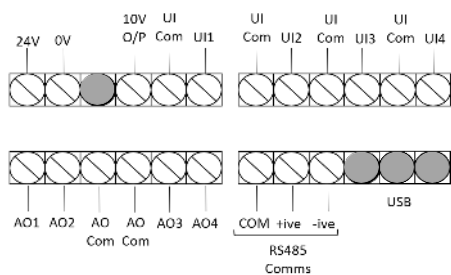

### IO/COM-8AO

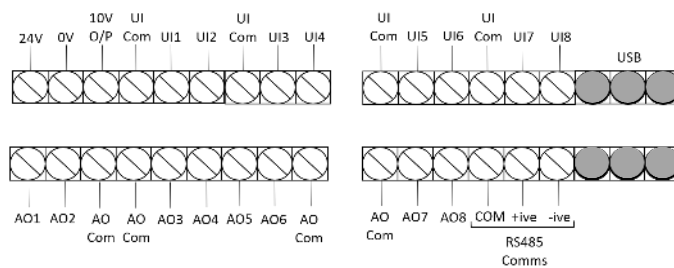

### IO/COM-4DO

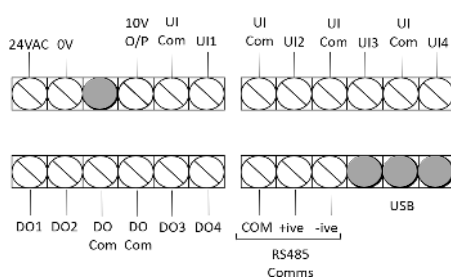

### IO/COM-8DO

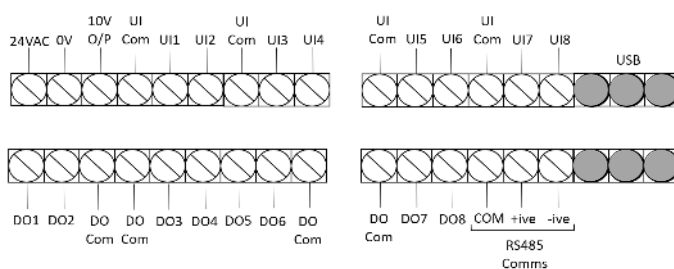

### IO/COM-4R

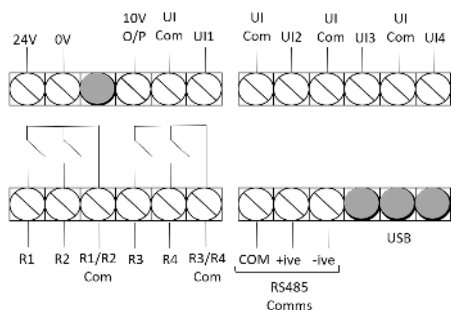

### IO/COM-4AO4DO

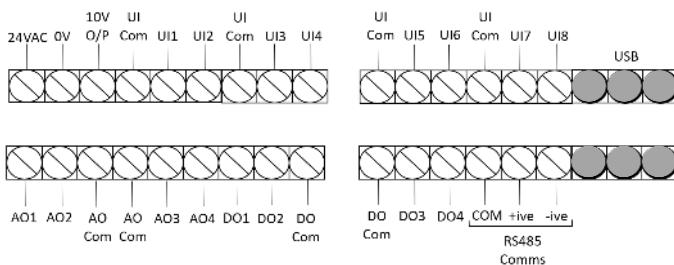

### IO/COM-8R

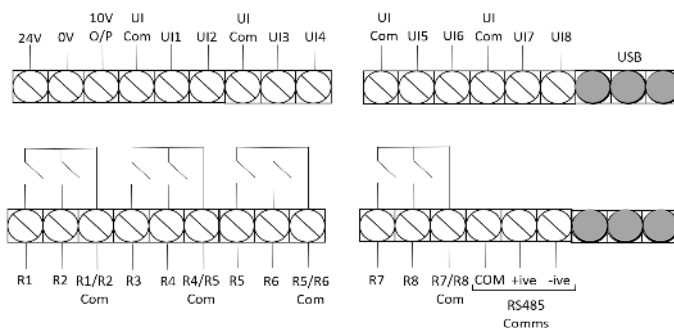

#### End of Line Resistor:

The units are supplied with an inbuilt end of line resistor. This is disabled as default. To enable an end of line resistor, remove the bottom right terminal guard on the unit and move the position of the jumper to connect both legs. In this position the 120ohm end of line resistor is now made. Note: this should only be enabled on the devices at the end of the RS485 daisy chain network.

## Application Notes:

### Pulse Counting:

When a UI is set as a Digital Input, the UI will provide both monitoring of contact condition and pulse counting with a max pulse count of 65535. If multiple UIs are set as Digital Inputs they will each have a limit of 65535 counts. It is recommended to save the count periodically, reset the counter and add to a rolling total being stored at the BMS or connected network controller to avoid data loss under a power outage or counter reset.

Once the limit is reached the count will loop back to 0 and increment from there as more pulses are counted.

Each counter can be individually reset via the BACnet or Modbus network if required.

When configured as digital input the inputs are compatible with open collector outputs.

### Low Pass Filter:

A low pass filter value can be allocated to the input to provide a rolling average of the input measurement when an input is configured as an analogue or resistive input. The rolling average period can be set from 0 to 60 seconds where 0 is no low pass filter set. The low pass filter is designed to provide a more stable input reading.

If multiple UIs are set as an analogue or resistive input, each input can have a different low pass filter value if required. The low pass filter is set via the BACnet or Modbus network. See the BACnet or Modbus manuals for more details.

### 10V Output Application use (10V O/P):

The 10V output can be used for feedback with Input signal applications, switching the fixed 10V (wetting voltage) through dry contacts into a UI that will be set to an analogue input which creates a type of DI signal for example: 10V ON or 0V OFF.

This one 10V signal can be used for the common side of multiple ON/OFF Analogue Inputs.

This 10V output can also be used through a resistive network via multiple dry switched contacts or a multi-position selector switch to signal varying voltage levels into one configured Analogue input. The variable voltage signal can be used to increase the number of module inputs when required.

Resistors	Voltage
20 k $\Omega$	2.1V
4.7 k $\Omega$	4.7V
2.7 k $\Omega$	6.1V
1 k $\Omega$	8.1V

The resistor values shown in the table are standard. The resulting error on the voltage for the analogue input is  $<0.2V>$ . A 10K ohms resistor needs to be fitted across the analogue input to earth.

Diagram shows an application using a selector switch to produce the variable voltage

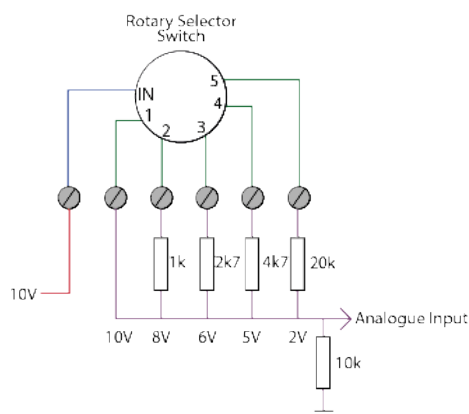

## Recommended Cable Specification

Item	Cable Spec & Reference	Requirements
BACnet MS/TP or Modbus RTU Communications to BMS /Router and Smart IO modules	Belden 9841 (0.2mm <sup>2</sup> ) Twisted Pair with Drain wire and foil wrap or equivalent. Note: Drain wire can be used to as a common connection. <b>Note: Must Be suitable for RS485 Standard</b>	Daisy chain network configuration only. The cable shield must be connected to Earth ground at the network router end only. <b>Note: Ensure a 120 ohms resistor is fitted to end of line controller.</b>
Connection between Titan Configuration Tool and Smart IO	Mini USB to USB	<b>Note: Titan can supply if required. Not supplied with product.</b>
Resistive Inputs	2 Core twin twisted screened:- 0.75mm -1mm Belden 8760 (0.82mm <sup>2</sup> ) or Equivalent	Screen Earthed at Module end only
0-10V Inputs	2 Core twin twisted screened:- 0.75mm -1mm Belden 8760 (0.82mm <sup>2</sup> ) or Equivalent	Screen Earthed at Module end only
Digital inputs	2 Core twin twisted screened:- 0.75mm -1mm Belden 8760 (0.82mm <sup>2</sup> ) or Equivalent	Screen Earthed at Module end only

- All Low voltage cables must be segregated from any mains carrying inductors and they should not be run in the same containment system
- All low voltage cables must not run in close proximity to any mains AC inductive loads such as florescent fittings and electric motors
- All cable connections into Titan Products controllers should use ferrules to prevent short circuits.

*Titan Products Ltd. reserve the right to alter or amend this product in any way without notification*