



SMART DUCT CO2 SENSOR with BACnet MS/TP & Modbus RTU communications

- Accurate CO2 monitoring
- Additional, in-built networkable I/O
- Easily addressed
- Reduce on-site wiring and installation costs through monitoring over BACnet MS/TP or Modbus RTU networks

The Smart Sensors from Titan Products are designed to monitor environmental conditions and expose this directly onto a BACnet MS/TP or Modbus RTU network.

Providing additional, in-built and networkable I/O, the sensors are supplied with 1 x Digital Output (DO) and 1 x Digital Input (DI), allowing flexible on/off environmental and non-environmental control loops to be set up and read / written to via the BACnet communications. See Control Section for more information.

Measuring multiple environmental conditions over one network bus and integrating this with onboard local control, can drastically reduce on site wiring, installation and commissioning costs.

Accurate monitoring and control reduces energy costs and allows the building to be maintained at comfortable occupancy levels which is proven to increase occupant productivity.

Easily addressed via the on-board DIP switches, the sensors are ideal for a wide range of applications that require accurate, networkable monitoring across open systems along with control on demand in building types such as schools, universities, retail, offices and leisure centres.

SPECIFICATION

Power Supply:	24VAC/DC +/- 10% (If DO is used Power Supply must be AC)
Power Consumption:	50mA (Does not include DO Load if used)
Communications:	BACnet MS/TP or Modbus RTU (selectable)
BACnet Baud Rates:	9600, 19200, 38400, 76800
Modbus Baud Rates:	9600, 19200, 38400, 57600
Outputs:	1 x Digital Output (DO) rated at 350mA
Inputs:	1 x Digital Input (DI)
Measured Range:	0-2000ppm
Operating Temperature:	5 to 45°C
Operating Humidity:	0-80% non-condensing
Protection:	IP65
Connections:	Screw terminals for 0.3mm ² to 1.5mm ² cable
Recommended Cable type:	Screened Twisted Pair 0.75mm - 1mm, screen earthed at controller end only
Country of Origin:	UK
Product Code:	TPDCO2-COM



DIMENSIONS

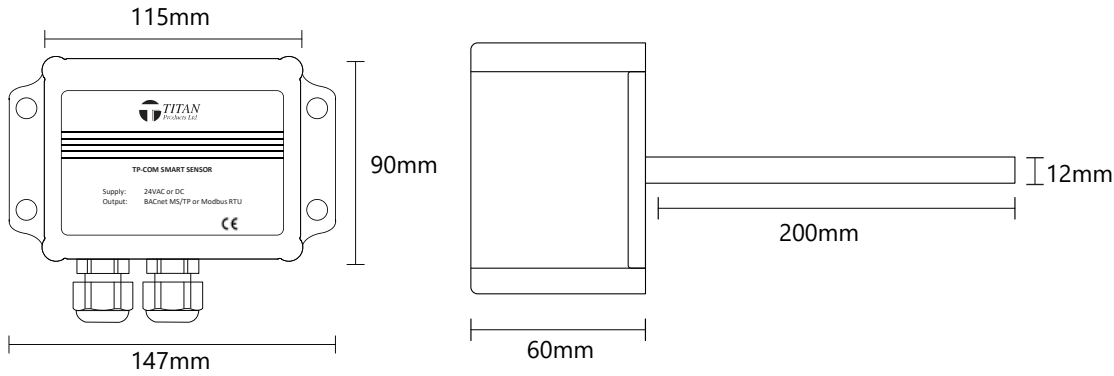

CONNECTIONS

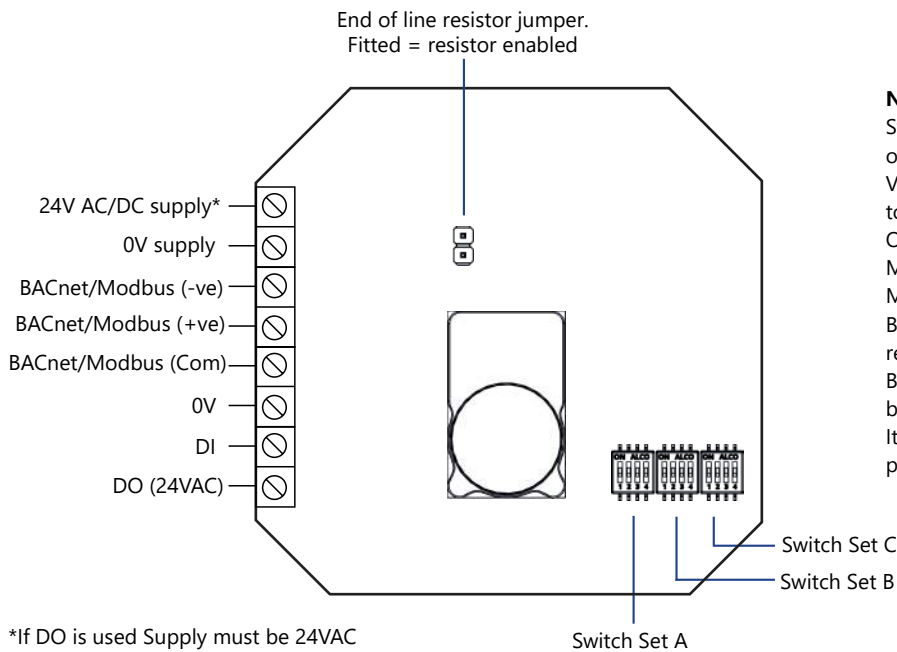

Note

Switches use Binary to set device BACnet MAC address or Modbus Slave Address.
Value achieved by adding relevant switch values together. See examples in table. Switches all OFF or all ON are not valid settings for addressing.
Max MAC address for BACnet systems is 127.
Max Modbus Slave address is 254. Address 0 is not valid.
BACnet Device ID = Set MAC address + 151. It is recommended this is altered during commissioning via BACnet communications once the device is discovered by the BMS.
It is recommended to set the network addresses prior to powering up the device.

BACnet / Modbus Settings (1-4 Switch A)

Function	Switch	Operation
Communications Selection	SW1	Off = BACnet MS/TP On = Modbus RTU
Modbus Setting (only applicable if SW1 ON)	SW2	Off = Communications parameters from Modbus Register On = No parity 2 Stop Bits
Communications Baud Rate	SW3 & SW4	See table

BACnet Baud Rates: 9600, 19200, 38400, 76800

Modbus Baud Rates: 9600, 19200, 38400, 57600

Baud Rate	SW3 Setting Position	SW4 Setting Position
9600	OFF	OFF
19200	ON	OFF
38400	OFF	ON
76800 (BACnet only)	ON	ON
57600 (Modbus only)	ON	ON

BACnet MAC / Modbus Slave Address Settings (1-4 Switches B & C):

Address example	Switch B				Switch C			
	SW1 (1)	SW2 (2)	SW3 (4)	SW4 (8)	SW1 (16)	SW2 (32)	SW3 (64)	SW4 (128)
1	ON	OFF	OFF	OFF	OFF	OFF	OFF	OFF
2	OFF	ON	OFF	OFF	OFF	OFF	OFF	OFF
3	ON	ON	OFF	OFF	OFF	OFF	OFF	OFF
4	OFF	OFF	ON	OFF	OFF	OFF	OFF	OFF
5	ON	OFF	ON	OFF	OFF	OFF	OFF	OFF
10	OFF	ON	OFF	ON	OFF	OFF	OFF	OFF
15	ON	ON	ON	ON	OFF	OFF	OFF	OFF
20	OFF	OFF	ON	OFF	ON	OFF	OFF	OFF
50	OFF	ON	OFF	OFF	ON	ON	OFF	OFF
100	OFF	OFF	ON	OFF	OFF	ON	ON	OFF
127	ON	ON	ON	ON	ON	ON	ON	OFF
150	OFF	ON	ON	OFF	ON	OFF	OFF	ON
254	OFF	ON	ON	ON	ON	ON	ON	ON

Smart Sensor Digital Output Activation

The Smart Sensors from Titan Products are all supplied with ON/OFF control options via a Digital Output (DO) as standard. The DO control can be enabled / disabled via number of methods to suit a number of varying application types. These methods are set up via the BACnet communications of the Smart Sensor and include:

- Manually activated via a write from a connected BMS or Network Controller.
- By allocating the Digital Input (DI) to the DO action. This will enable the DO whenever the DI is active.
- By allocating the on-board Push Button (if fitted) to the DO action. This will enable the DO whenever the Push Button is pressed. Pressing the Push Button again will de-activate the DO or enable control again dependant on the configuration of the sensor.
- By utilising the in-built Temperature and Humidity Environmental Control features of the sensor. See *Environmental Control Options* below.

It is also possible to manipulate the timing of the DO switching ON or OFF. See *Delay OFF* and *Timer Control* sections below. For Control Action using the DO the sensor power supply must be 24VAC.

Environmental Control Options

When utilising the in-built Environmental Control functions of the smart sensor, it is possible to set the control logic to activate on a rising or falling environmental condition. See *Rising Control* and *Falling Control* options below.

To allocate a control function to an environmental condition (Temp / Hum) this is selected via MSV301. Once an environmental variable has been allocated to control via MSV301, a control set point, hysteresis settings and the type of control (rising or falling) need to be set.

Note: Please see full BACnet manual for all BACnet points and more details. The visibility of the control block related objects depends on MSV301 selection. If MSV301 is changed, the device object has to be re-scanned to access the unveiled control objects.

Hysteresis settings

The hysteresis acts as the switching differential between the ON and OFF points of control. It is possible to set the hysteresis with the set point balanced in the middle (default), bias the set point below the hysteresis (-) or bias the set point above the hysteresis (+).

Rising Control

When selected, Rising Control will enable the sensor DO based on an increase in the measured variable.

Application Example: a cooling cycle being enabled if the temperature increases within a space or an extract fan being enabled if humidity rises.

Falling Control

Falling control will enable the DO based on a decrease in the measured variable.

Application Example: a heating cycle being enabled if the temperature decreases within a space or extract systems being shut off if humidity levels fall to a low or unoccupied position.

Rising Control with balanced set point (Default)

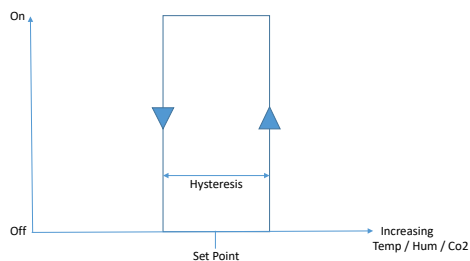

Falling Control with balanced set point (Default)

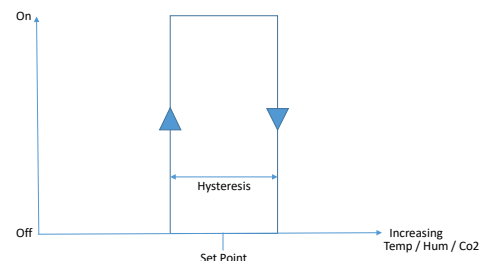

Rising Control with negative (-) biased set point

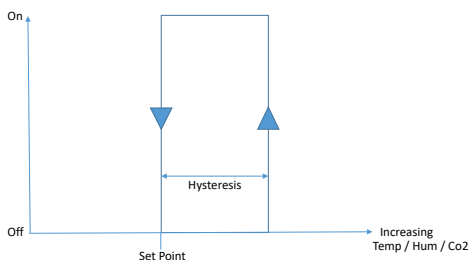

Falling Control with negative (-) biased set point

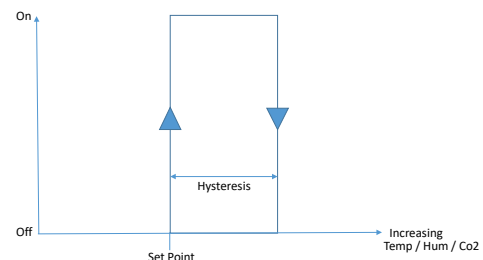

Rising Control with positive (+) biased set point

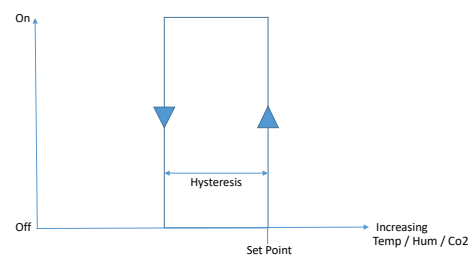

Falling Control with positive (+) biased set point

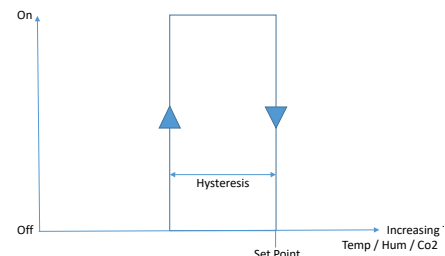

Activation of Control

Once the control logic has been set up within the Smart Sensor, it is possible to set when the control loop will be operational. This can be set to run:

- All the time.
- When the Push Button (if fitted) is pressed.
- When the on-board Digital Input is activated.
- When activated via the BMS.

This ensures the control is only operational when required.

If set to run all the time, the sensor will activate the DO each time the measured condition reaches the control ON point.

If activated via the Push Button, Digital Input or BMS the Environmental Control will only be operational until the Push Button, Digital Input or BMS is activated again. At this point the Environmental Control will be inhibited and the sensor will act purely as a monitoring device until the control is activated again.

When Environmental Control is being activated by an input on the sensor, the last command from the BMS, Push Button or Digital Input takes priority.

The BMS can write a direct master override to the DO by writing to BO100.

Delay OFF

It is possible to apply a Delay OFF timer to the Environmental Control.

This will ensure the Environmental Control action remains activated for a set time after the control is disabled by the push button, digital input or BMS. The Delay OFF is enabled / disabled via the BACnet settings along with the associated timer period.

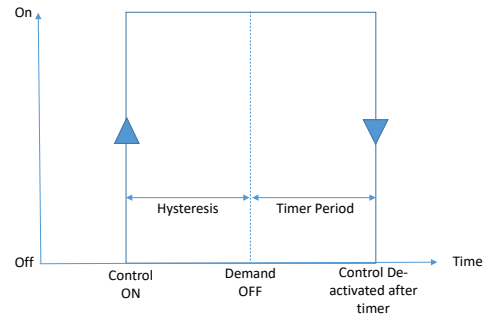

Visibility of Control Action

The control action (BV 360) is fully readable via the BACnet communications. This allows the control action within the sensor to be read by the BMS and used to trigger other plant in the space or building via the BMS without utilising the DO on the sensor if required. This feature allows the sensor DO to be triggered by a different method (manually via the BMS, via the DI or via the push button if fitted), creating the possibility for 2 simple control loops via the sensor and BMS.

Non-Environmental Enable / Disable Control

When no Environmental Control loop is required the DO can be enabled directly via:

- Writing to a Binary Value via BMS
- Pressing the push button.
- Enabling the Digital Input.

Timer Control

During a non-environmental control action, timer options can be configured as below:

Timed ON/OFF

On activation via the BMS, Push Button or Digital Input, the DO is enabled and the set timer period is started. The DO remains enabled until the timer completes or the BMS, Push Button or DI is activated again to cancel the timer and control. The DO then remains disabled until the next activation.

Application Example: This control action can be used to purge a space with fresh air after a period of high occupancy. E.g. Natural Ventilation applications in educational buildings.

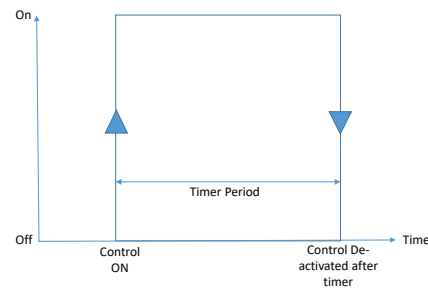

Timer Reset Off

On activation via the BMS, Push Button or DI, the sensor DO is enabled and the set timer is started. The DO will remain enabled until the set timer has run. If either the BMS, Push Button or DI are activated again before the timer has elapsed, the DO remains enabled and timer will be reset.

Application Example: This control action can be used for occupancy control of lighting or plant equipment within meeting rooms or office spaces.

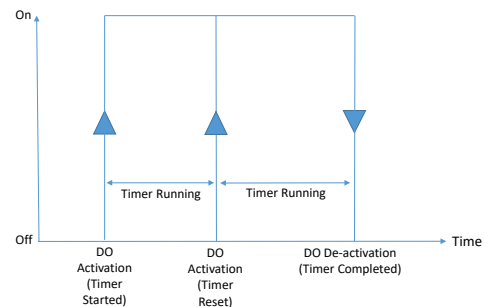

Sensor Notes

1. If the Digital Input is used with a latching switch, Close / Open circuit = ON/OFF. When closed the switch will enable the control or the DO (dependant on configuration) for the duration of the closed circuit. When the Digital Input is open circuit, control or DO (dependant on the configuration) is disabled.

2. If the Digital Input and/or Push Button are not used within the application, these objects should be taken out of service to allow the BMS to write to the respective objects to enable / disable the control or DO (dependant on configuration). This feature can be utilised during environmental or non-environmental control strategies

3. Solvents in the air derived from sources such as paints, cleaning products and adhesives can have a detrimental impact on the sensor cell. All sensors should therefore be installed after the space has been decorated and any flooring fitted. The sensors should also be kept away from adhesives and should the housing require cleaning, a dry non-solvent based product must be used. Do not spray any liquid or cleaning products directly onto the ventilated housing. Exposing the sensor to such solvents or moisture will invalidate the product warranty.

4. Disposal: At the end of their useful life the packaging and product should be disposed of in accordance with the below depending on the country of your disposal:

- WEEE Directive 2012/19/EU and its amendments (EU).
 - The Waste Electrical and Electronic Equipment Regulations 2013 (as amended).
- Do not dispose of with normal household waste. Do not burn.